

R

R

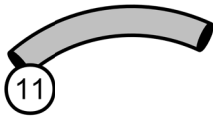

12

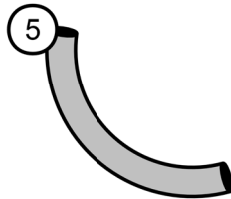
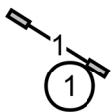
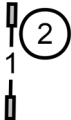
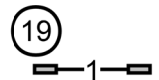
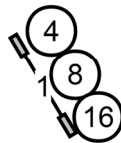
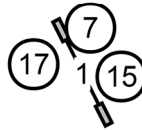
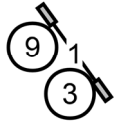
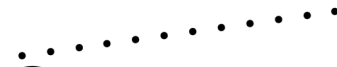

Enter@17

TS

Exit

L

Lower Camden County Dog Training Club  
Saturday November 22, 2025

**JWW Premier**

Designed by: Kristine Schmidt  
Judged by: Andrew Mellon

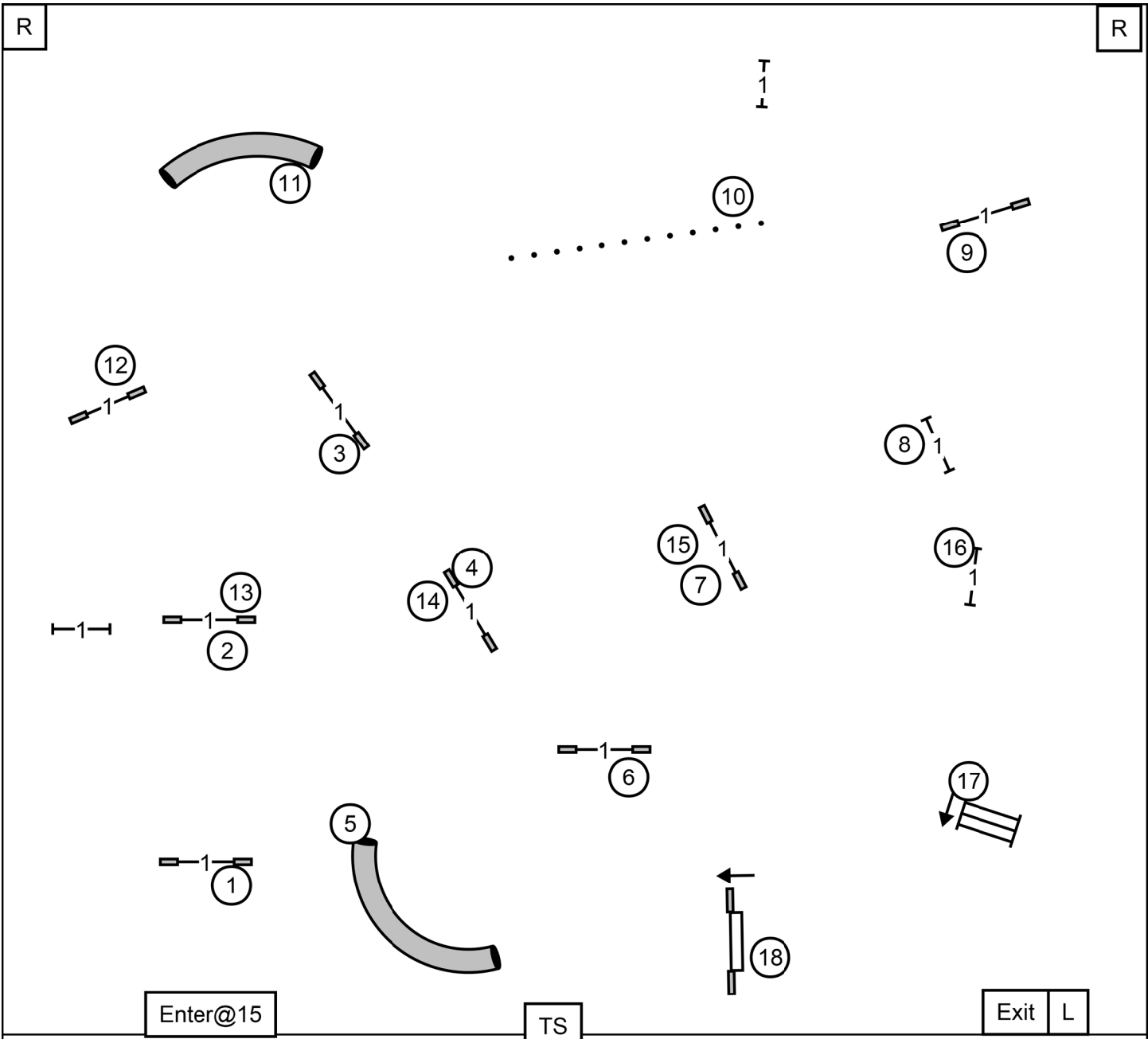

Lower Camden County Dog Training Club  
 Saturday November 22, 2025

**JWW Excellent/Masters**  
 Designed by: Kristine Schmidt  
 Judged by: Andrew Mellon

R

R

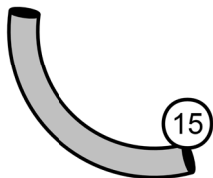
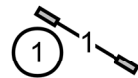
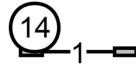
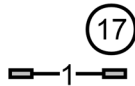
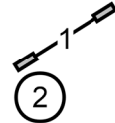
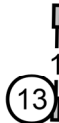
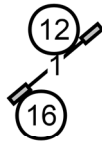
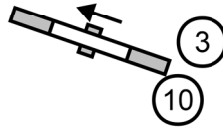
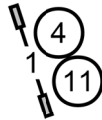
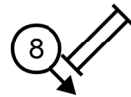
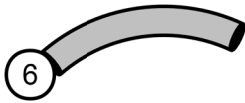

Exit L

TS

Enter@15

Lower Camden County Dog Training Club  
Saturday November 22, 2025

**T2B**  
Designed by: Kristine Schmidt  
Judged by: Andrew Mellon

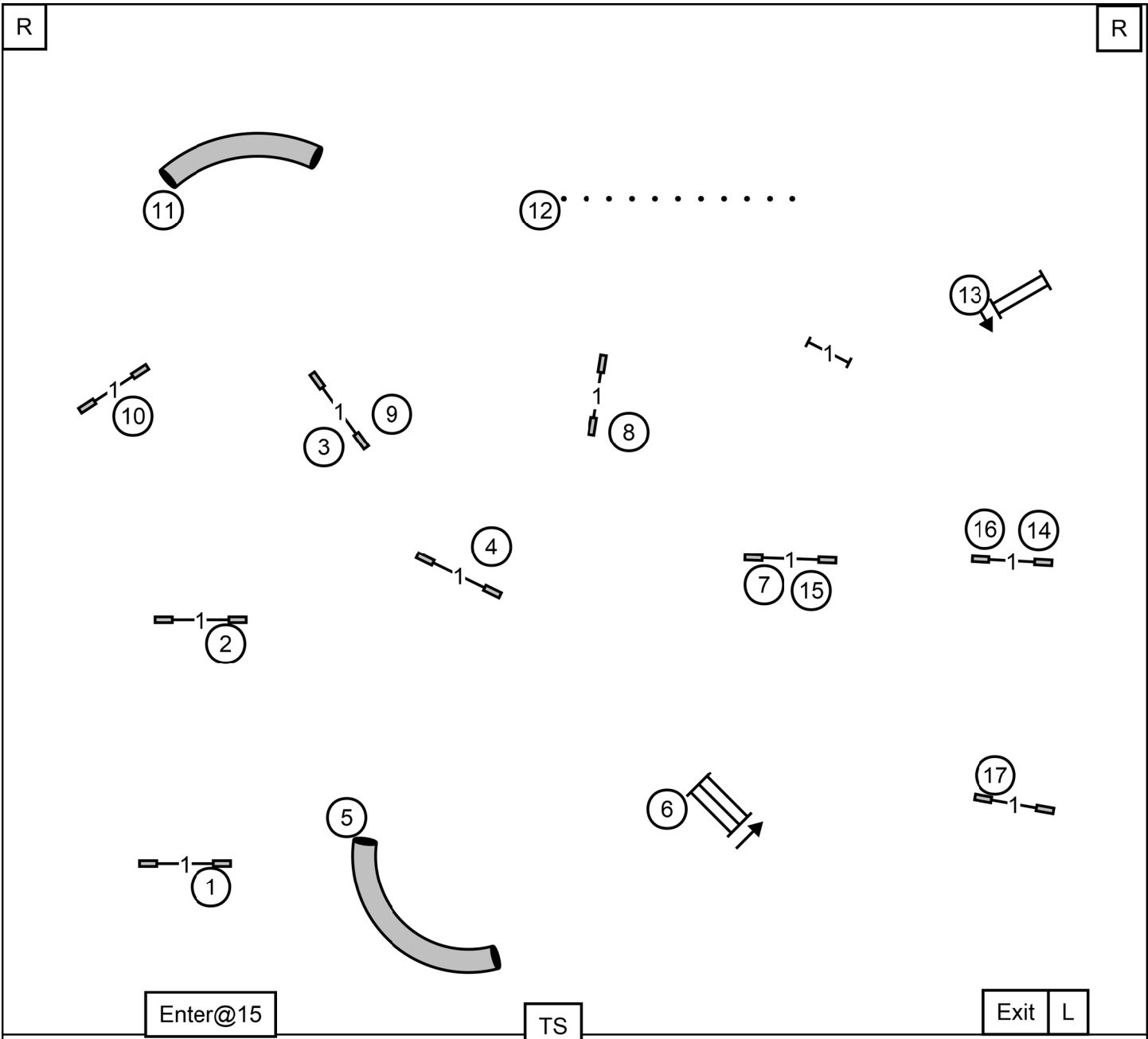

Lower Camden County Dog Training Club  
 Saturday November 22, 2025

**JWW Open**  
 Designed by: Kristine Schmidt  
 Judged by: Andrew Mellon

R

R

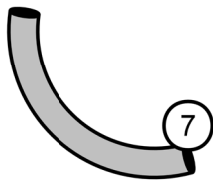
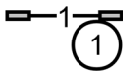
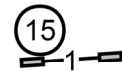
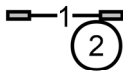
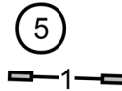
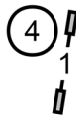
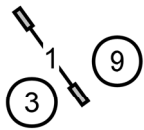
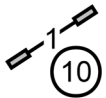
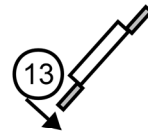
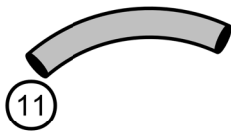

Enter@13

TS

Exit

L

Lower Camden County Dog Training Club  
Saturday November 22, 2025

### JWW Novice

Designed by: Kristine Schmidt  
Judged by: Andrew Mellon

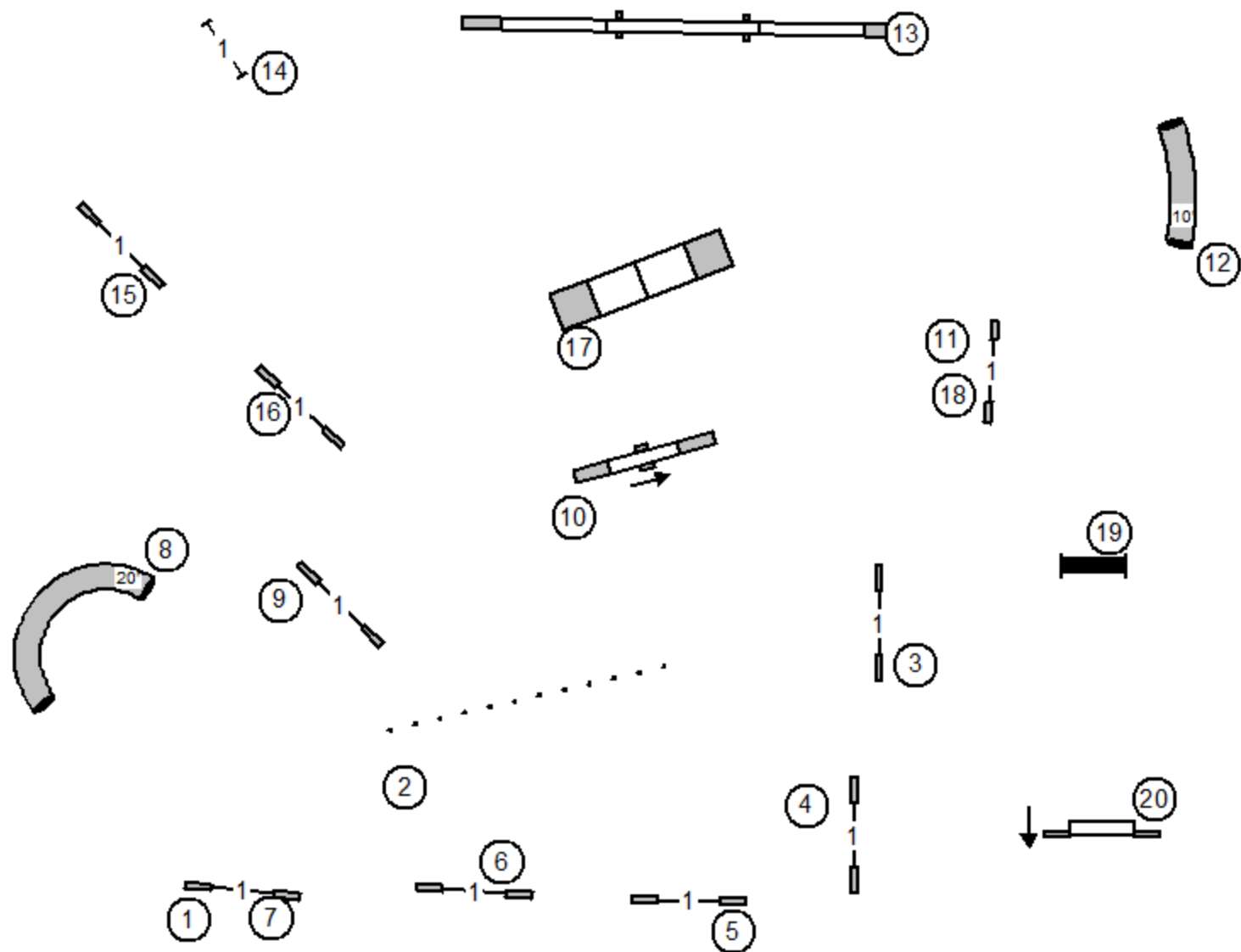

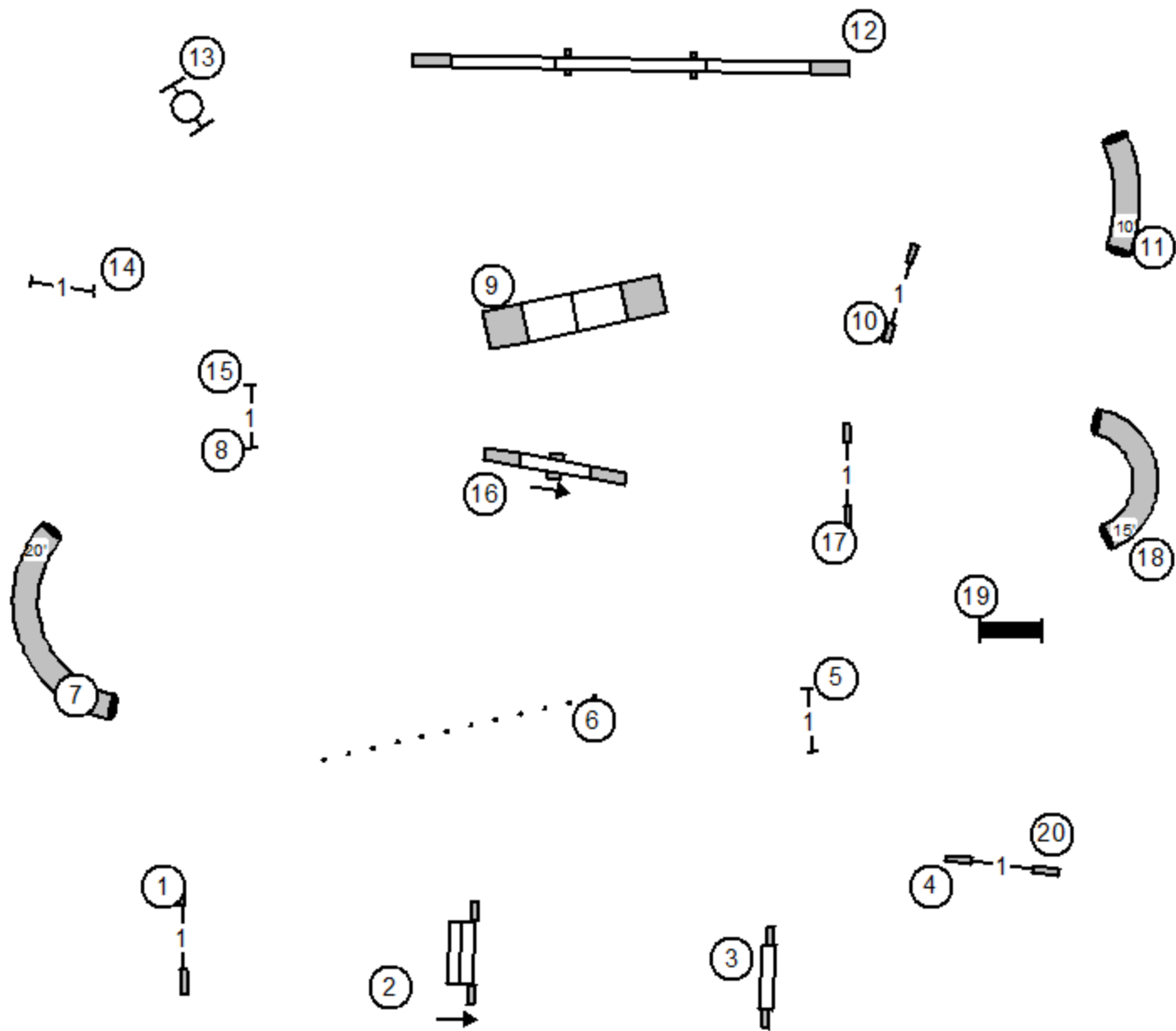

Enter

T/S

Exit

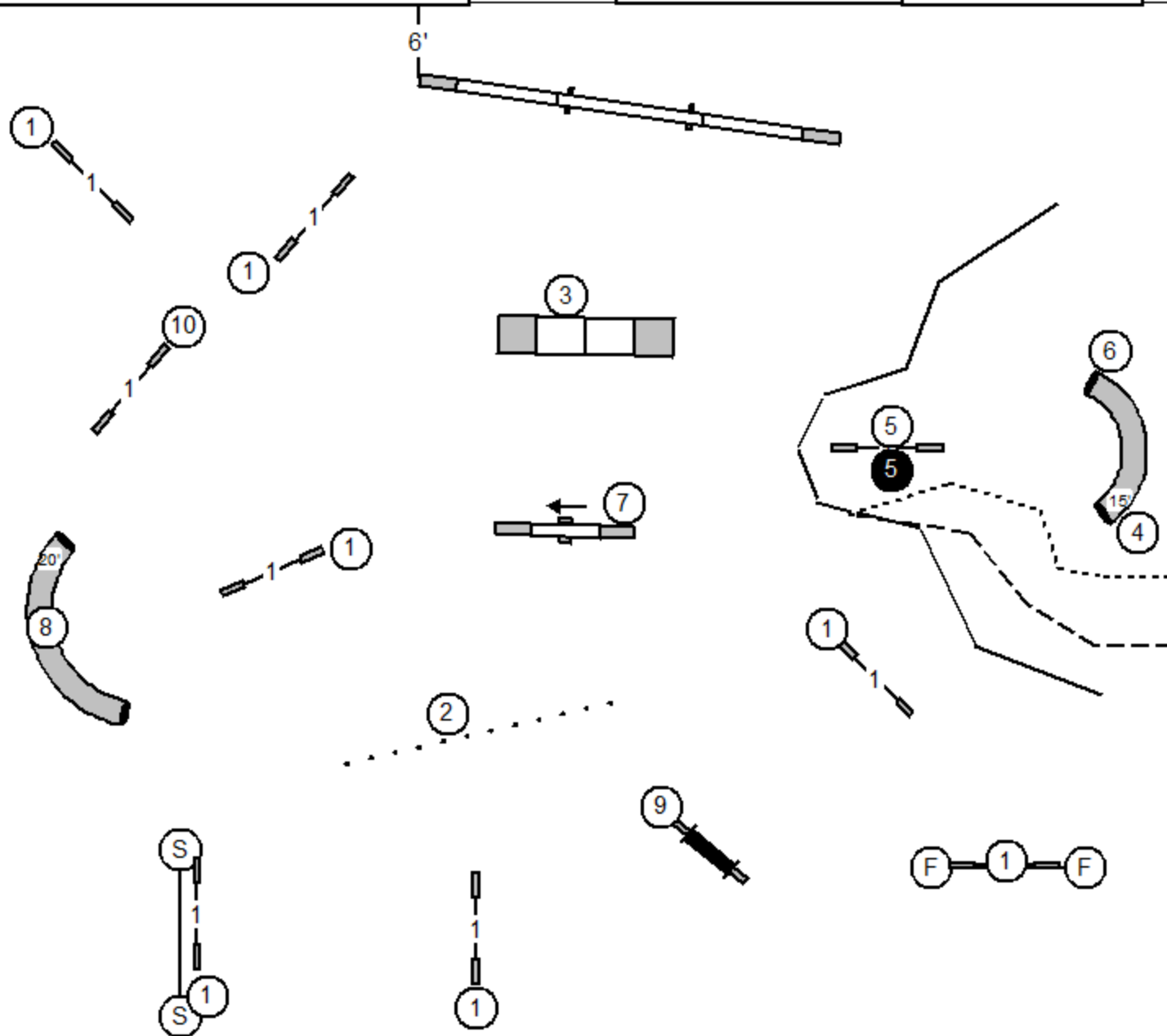

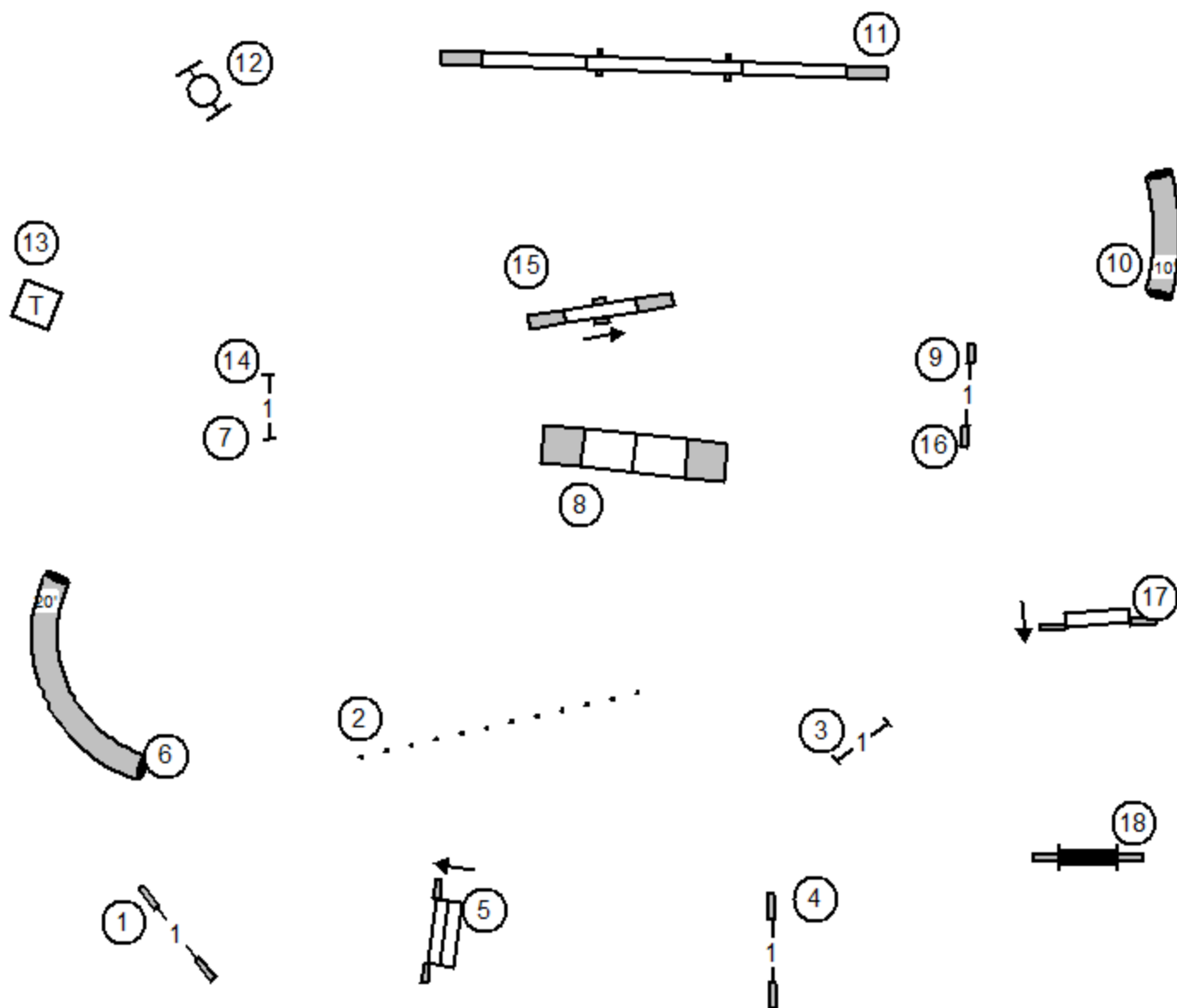

Enter

T/S

Exit

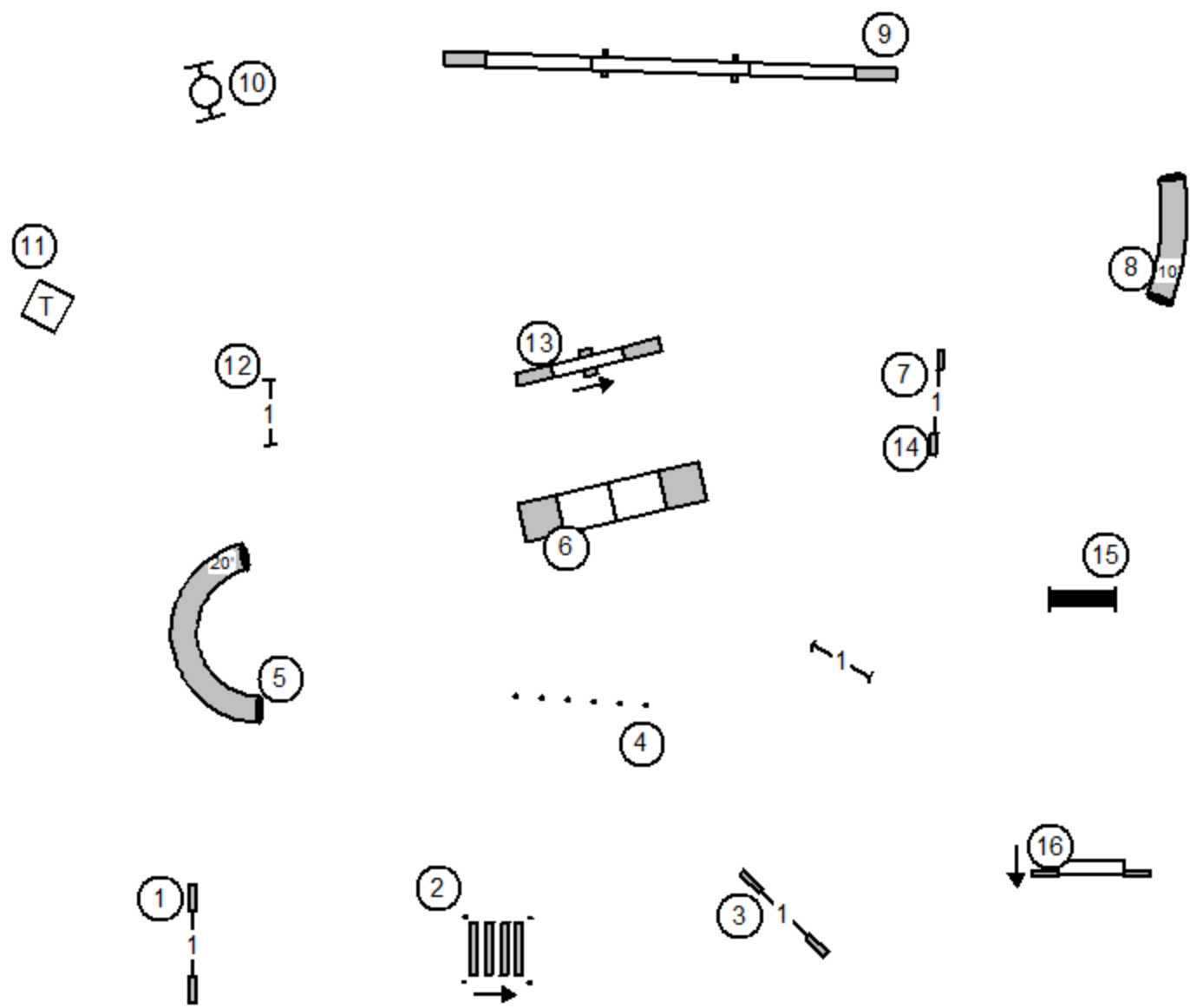

Enter

T/S

Exit