

T2B

Burlington County Kennel Club
Saturday, October 11, 2025
Premier Sports Center
Southampton, NJ
Judge ~ Katrina Walters

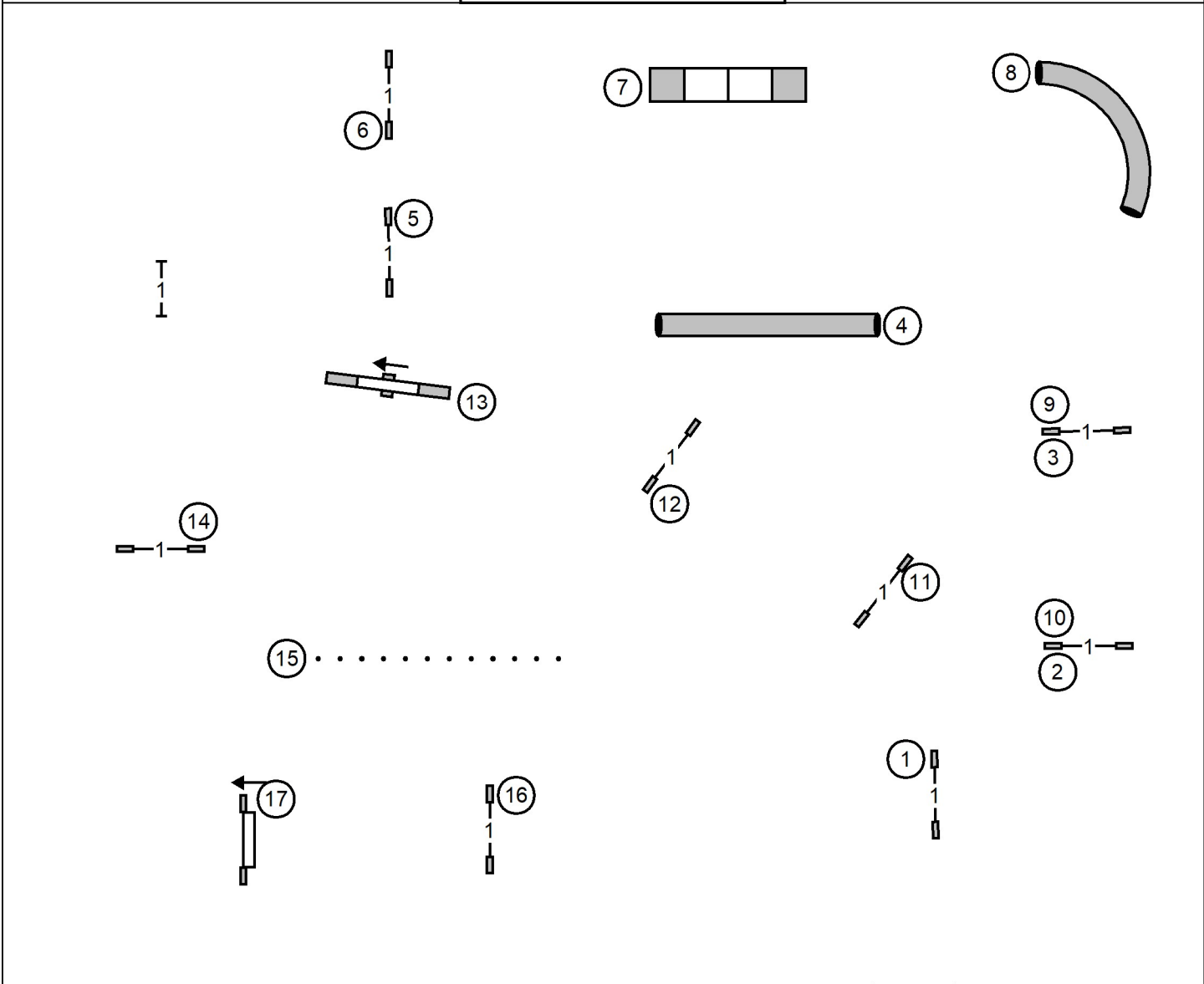

Exit

T/S

Enter

Premier STD

Burlington County Kennel Club
Saturday, October 11, 2025
Premier Sports Center
Southampton, NJ
Judge ~ Katrina Walters

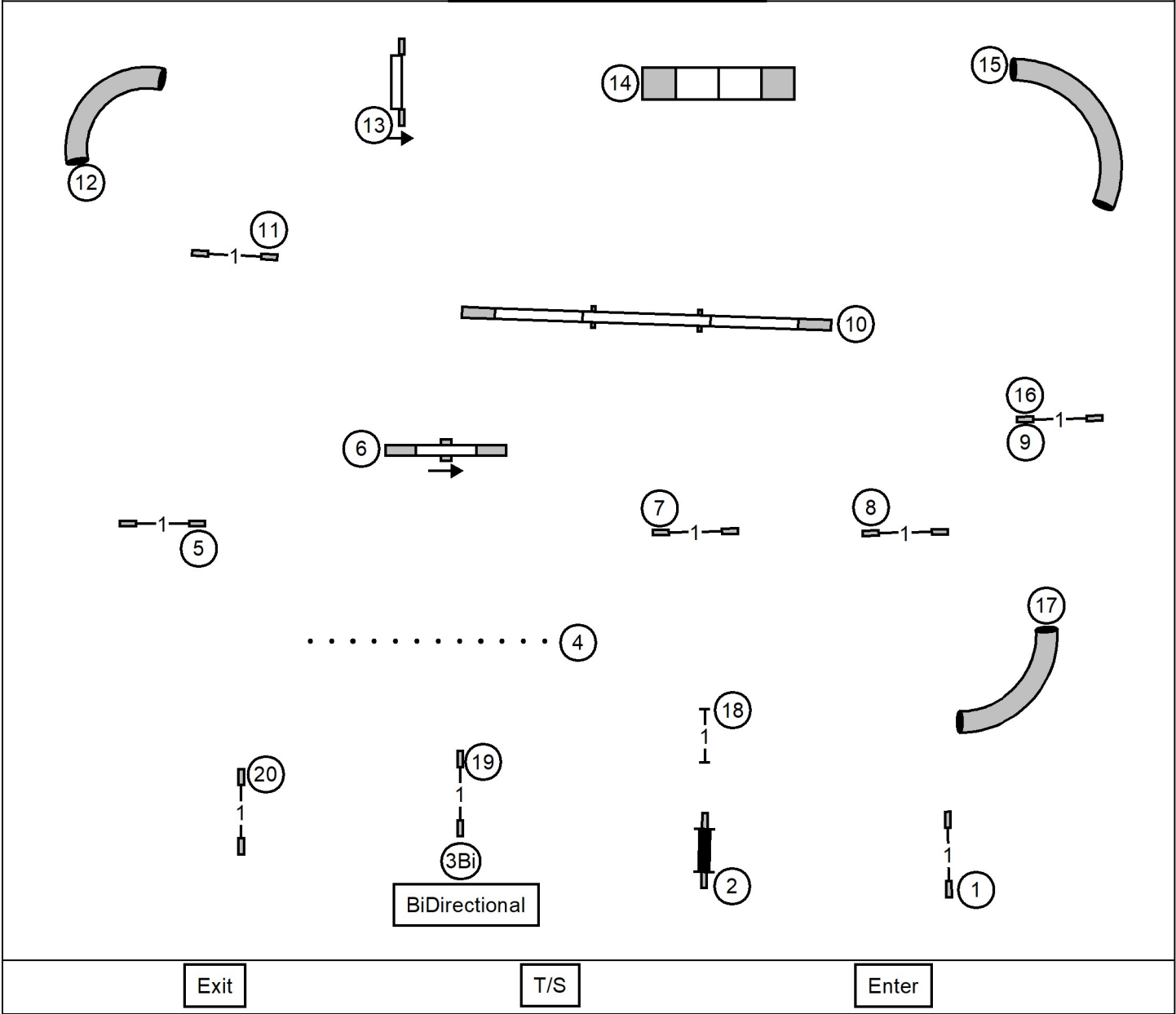

Master/Excellent STD

Burlington County Kennel Club
Saturday, October 11, 2025
Premier Sports Center
Southampton, NJ
Judge ~ Katrina Walters

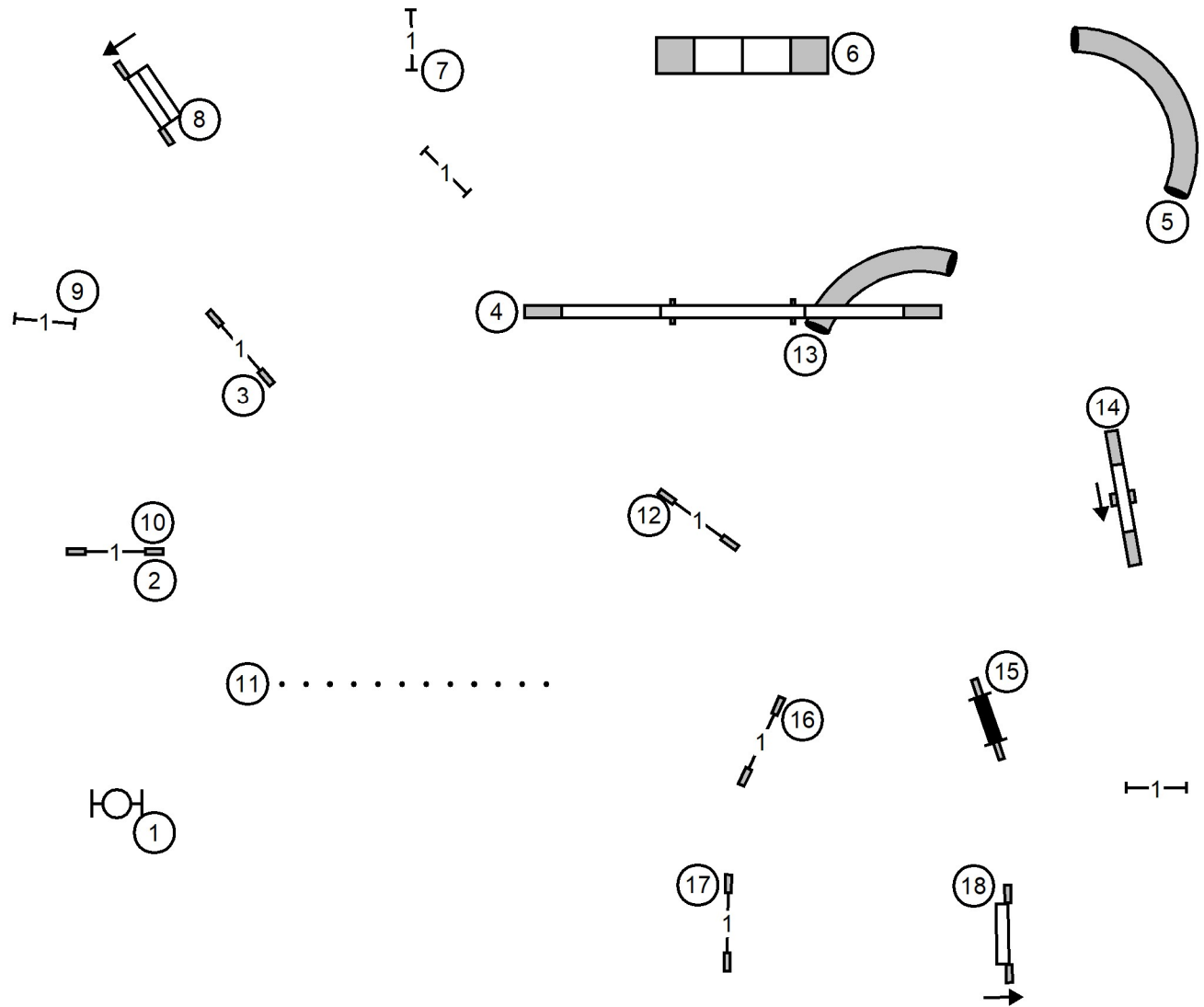

Enter

T/S

Exit

Open STD

Burlington County Kennel Club
Saturday, October 11, 2025
Premier Sports Center
Southampton, NJ
Judge ~ Katrina Walters

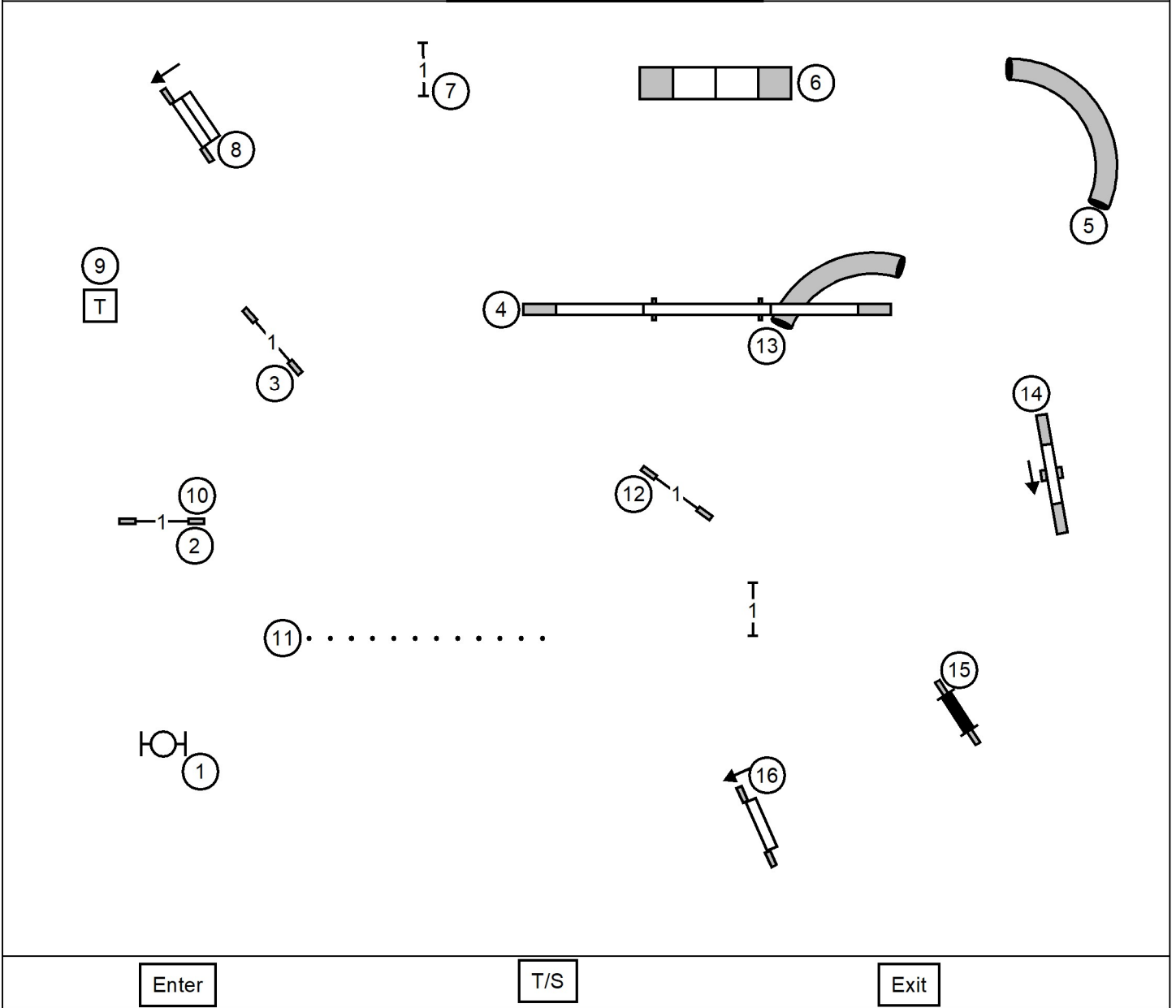

Novice STD

Burlington County Kennel Club
Saturday, October 11, 2025
Premier Sports Center
Southampton, NJ
Judge ~ Katrina Walters

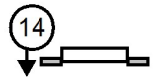
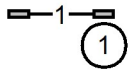
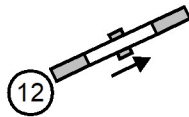
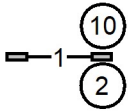
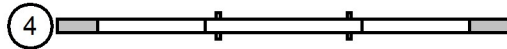
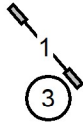
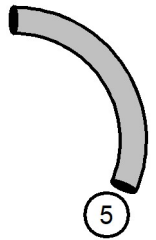
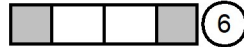
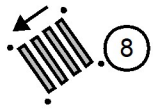

Enter

T/S

Exit

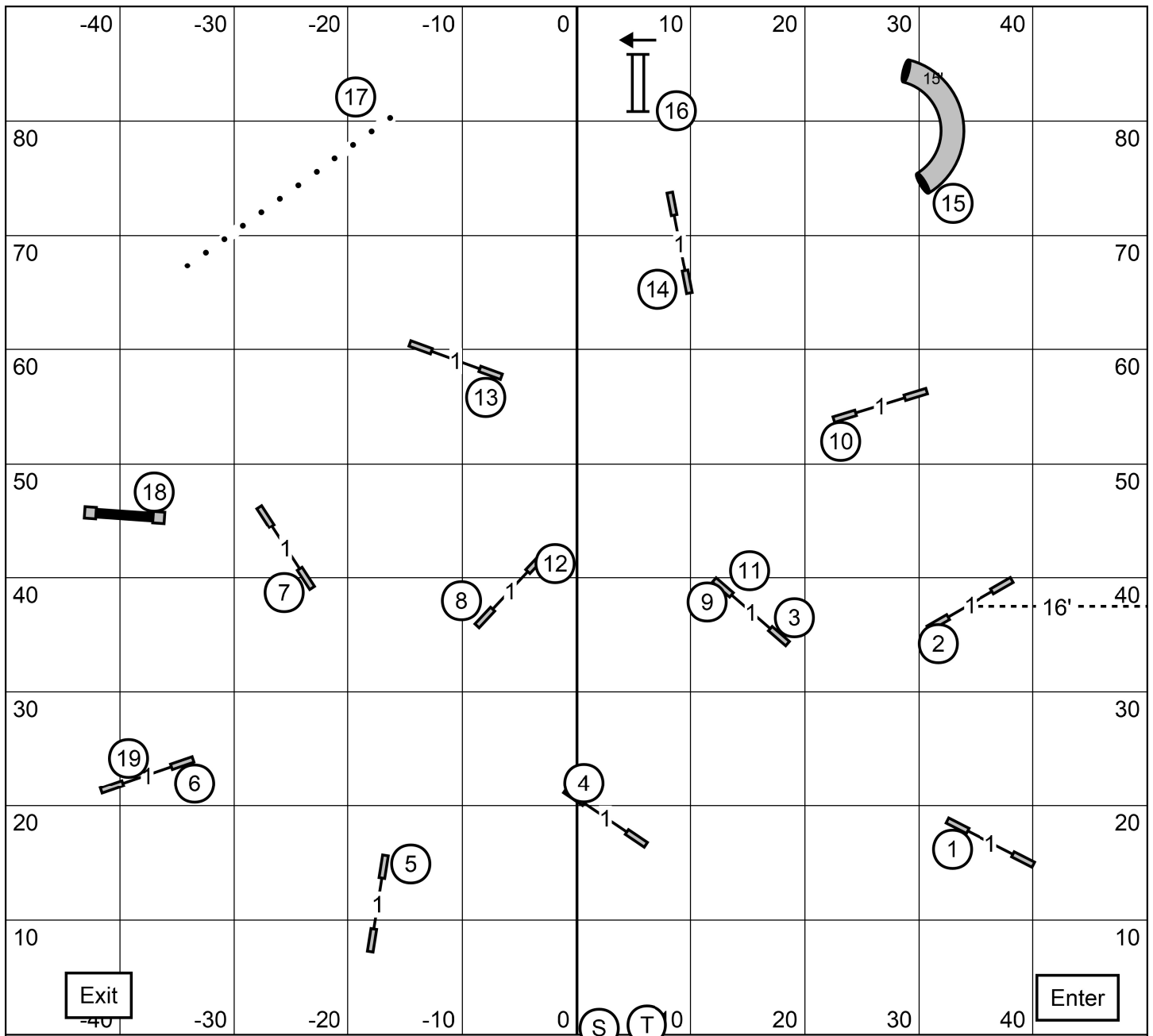

Burlington County Kennel Club Club
 Master/Excellent and P JWW
 Judge: Pamela R. Sturtz

Saturday, October 11, 2025
 Indoors on Soccer Turf
 Score _____

Yardage _____
 SCT _____
 Dog's Time: _____

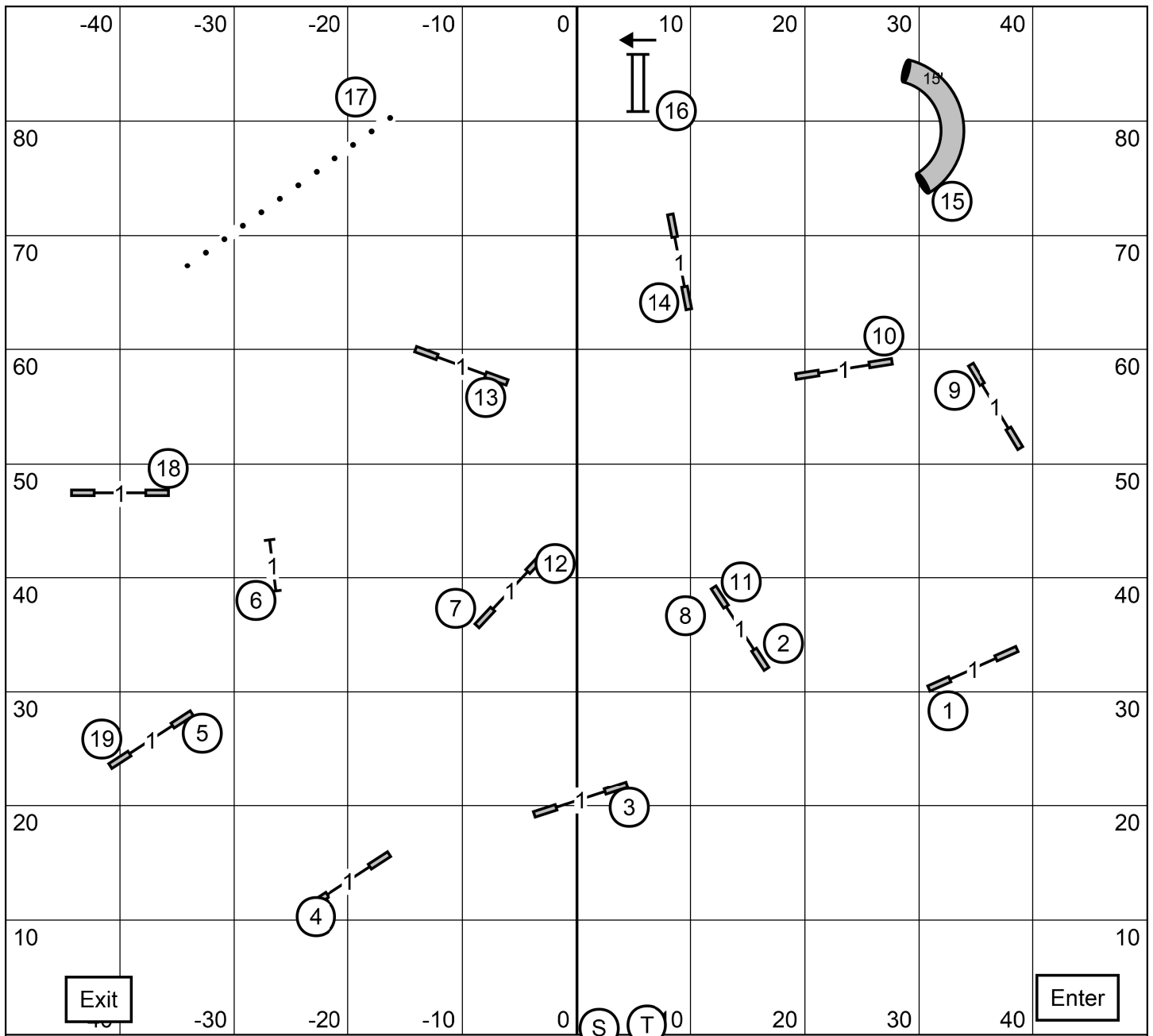

Burlington County Kennel Club Club
 Premier and P JWW
 Judge: Pamela R. Sturtz

Saturday, October 11, 2025
 Indoors on Soccer Turf
 Dog's Time: _____

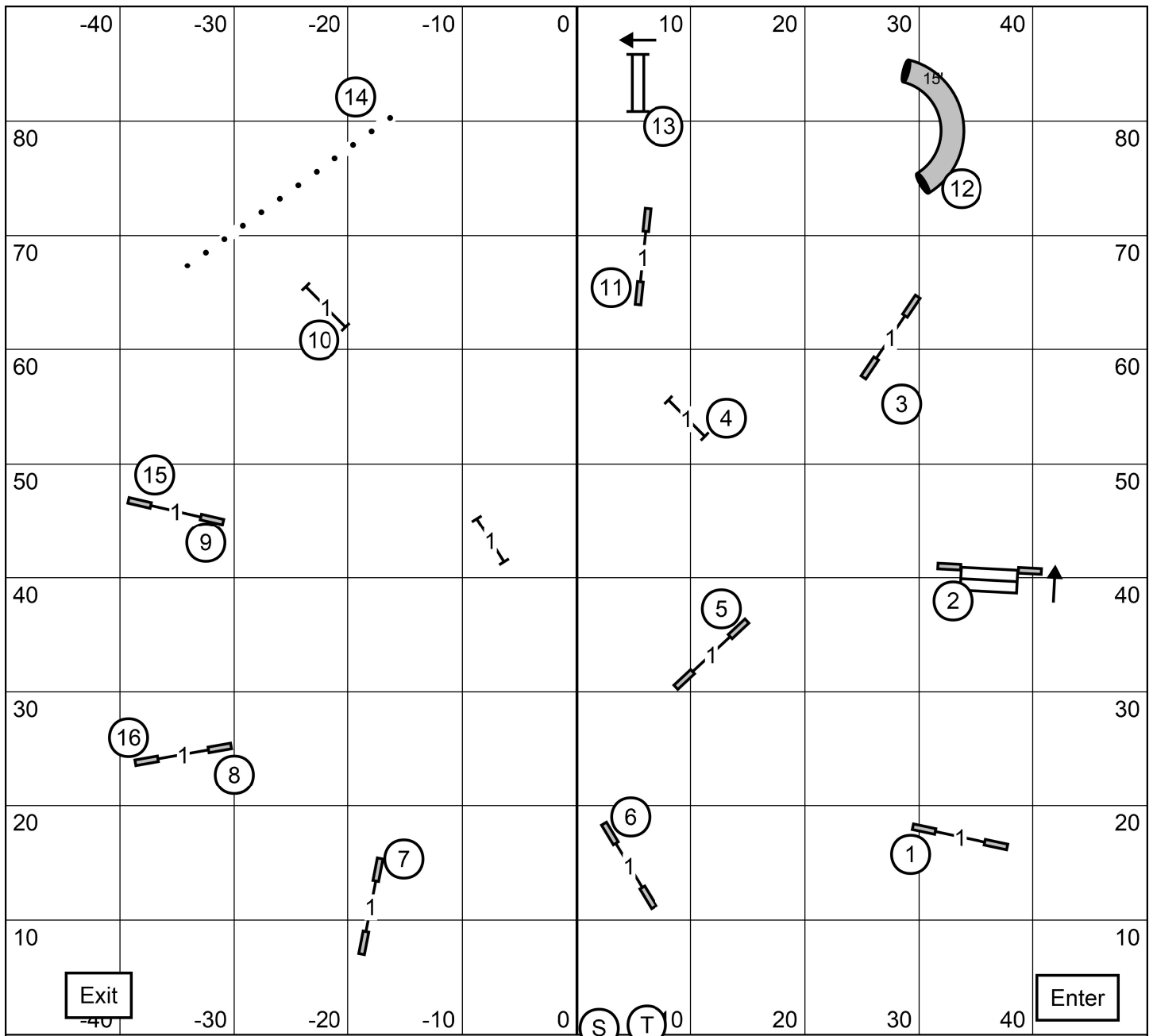

Burlington County Kennel Club
 Open and P JWW
 Judge: Pamela R. Sturtz

Saturday, October 11, 2025
 Indoors on Soccer Turf
 Score _____

Yardage _____
 SCT _____
 Dog's Time: _____

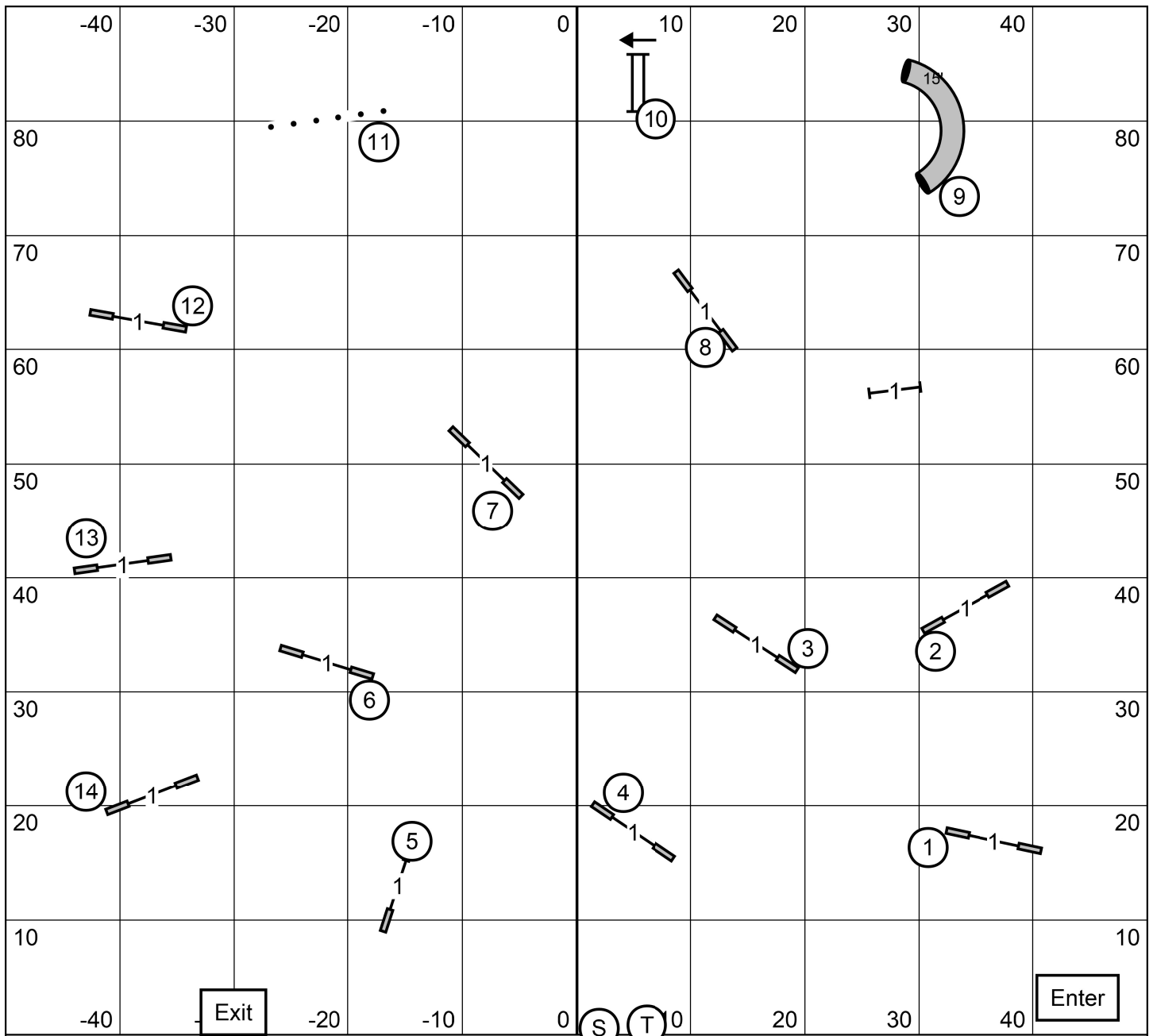

Burlington County Kennel Club
 Novice A, B and P JWW
 Judge: Pamela R. Sturtz

Saturday, October 11, 2025
 Indoors on Soccer Turf
 Score _____

Yardage _____
 SCT _____
 Dog's Time: _____